

shindaiwa

Shindaiwa Inc.
11975 S.W. Herman Rd.
Tualatin, Oregon 97062
Telephone: 503 692-3070
Fax: 503 692-6696
www.shindaiwa.com

Shindaiwa Kogyo Co., Ltd.
6-2-11 Ozuka-Nishi,
Asaminami-Ku, Hiroshima
731-3167, Japan
Telephone: 81-82-849-2220
Fax: 81-82-849-2481

©2003 Shindaiwa, Inc.
Part Number 72362-93115
Revision 9/03

Shindaiwa is a registered trademark
of Shindaiwa, Inc.
Specifications subject to change without
notice.

SHINDAIWA OWNER'S/ OPERATOR'S MANUAL 357 CHAIN SAW

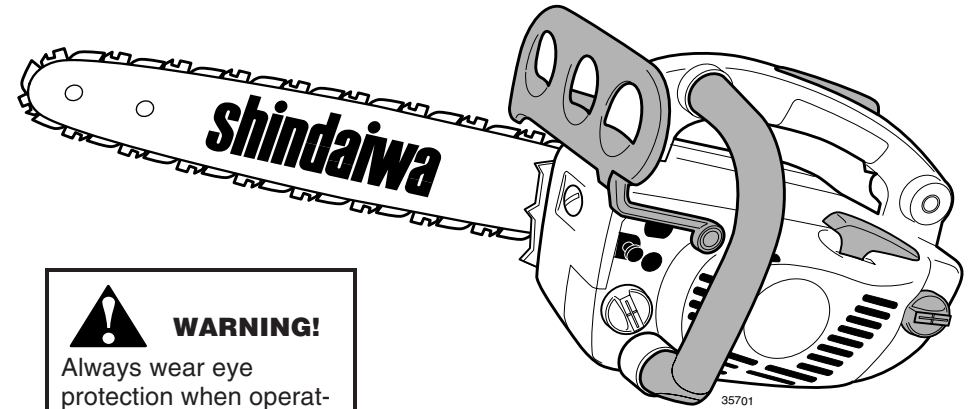

WARNING!

Always wear eye
protection when operat-
ing this unit.



WARNING!

Minimize the risk of
injury to yourself and
others; read this manual
and familiarize yourself
with its contents!

Part Number 72362-93115 Rev. 9/03

shindaiwa

MAINTENANCE, REPLACEMENT OR REPAIR OF EMISSION CONTROL DEVICES AND SYSTEMS MAY BE PERFORMED BY ANY REPAIR ESTABLISHMENT OR INDIVIDUAL; HOWEVER, WARRANTY REPAIRS MUST BE PERFORMED BY A DEALER OR SERVICE CENTER AUTHORIZED BY SHINDAIWA KOGYO CO., LTD. THE USE OF PARTS THAT ARE NOT EQUIVALENT IN PERFORMANCE AND DURABILITY TO AUTHORIZED PARTS MAY IMPAIR THE EFFECTIVENESS OF THE EMISSION CONTROL SYSTEM AND MAY HAVE A BEARING ON THE OUTCOME OF A WARRANTY CLAIM.

If other than the parts authorized by Shindaiwa Kogyo Co., Ltd. are used for maintenance replacements or for the repair of components affecting emission control, you should assure yourself that such parts are warranted by their manufacturer to be equivalent to the parts authorized by Shindaiwa Kogyo Co., Ltd. in their performance and durability.

OBTAINING WARRANTY SERVICE

All repairs qualifying under this limited warranty must be performed by a dealer authorized by Shindaiwa Kogyo Co., Ltd.

If any emission-related part is found defective during the warranty period, it is your responsibility to present the product to an authorized Shindaiwa dealer. Bring your sales receipts showing the date of purchase for this engine. The dealer authorized by Shindaiwa Kogyo Co., Ltd. will perform the necessary repairs or adjustments within a reasonable amount of time and furnish you with a copy of the repair order. All parts and accessories replaced under this warranty become the property of Shindaiwa Kogyo Co., Ltd.

To locate an authorized Shindaiwa dealer near you, contact your Shindaiwa Distributor. For the name and telephone number of the Shindaiwa Distributor in your area, please call Shindaiwa Inc. at (503) 692-3070 between the hours of 8:00 AM and 5:00 PM Pacific Standard Time.

THIS WARRANTY IS ADMINISTERED BY

Shindaiwa Inc.
11975 S.W. Herman Rd.
Tualatin OR. 97062
(503) 692-3070

Introduction

The Shindaiwa 357 Top-Handle saw has been designed and built to deliver superior performance and reliability without compromise to quality, comfort, safety, or durability.

Shindaiwa high performance engines represent the leading edge of 2-cycle engine technology, and deliver exceptionally high power at remarkably low displacement and weight. As a professional owner/operator, you'll soon discover why Shindaiwa is simply in a class by itself.

IMPORTANT!

The information contained in this manual describes machines available at the time of production. While every attempt has been made to give you the very latest information about your Shindaiwa 357 chain saw, there may be some differences between your saw and what is described here. Shindaiwa Inc. reserves the right to make changes in production without prior notice, and without obligation to make alterations to machines previously manufactured.

Contents

	Page
Attention Statements	4
Product Description	5
Specifications	6
Safety Information	7
Installing the Bar and Chain	11
Adjusting the Saw Chain	13
Mixing Fuel	14
Filling the Fuel Tank/Bar Oil	15
Starting the Saw	16
Carburetor Adjustments	19
Chain Brake	21
Cutting with the Saw	23
Routine Maintenance	27
Long-term Storage	29
The Saw Chain	30
Troubleshooting	33
Emission System Warranty	36

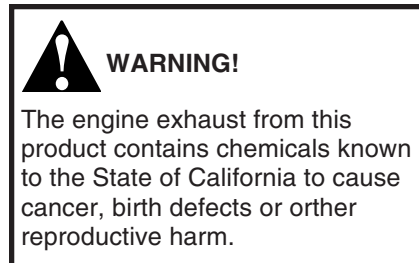

This symbol on the nameplate means this saw is listed by the Underwriters Laboratory, Inc.

Attention Statements

Throughout this manual are special “attention statements”.



WARNING!

A statement preceded by the word “WARNING” contains information that should be acted upon to prevent serious bodily injury.

CAUTION!

A statement preceded by the word “CAUTION” contains information that should be acted upon to prevent damaging your saw.

IMPORTANT!

A statement preceded by the word “IMPORTANT” is one that possesses special significance.

NOTE:

A statement preceded by the word “NOTE” contains information that is handy to know and may make your job easier.



Read and follow the Operator's Manual. Failure to do so could result in serious injury.



Wear eye and hearing protection at all times during the operation of this unit.



Do not operate this tool if you are tired, ill or under the influence of alcohol, drugs, or medication.

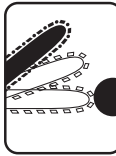

Beware of Kickback!

Kickback can occur whenever the tip of the guide bar touches an object while the saw is operating. Kickback may force the bar up and back toward the operator with a lightning-fast reaction!

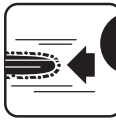

Pinching the saw along the top of the guide bar may force the bar rapidly back toward the operator. Pinching can occur whenever wood closes in around the moving chain.

All chain saw service, other than the items listed in the owner's manual maintenance instructions, should be performed by trained Shindaiwa chainsaw service personnel. (For example, if improper tools are used to remove the flywheel or if an improper tool is used to hold the flywheel in order to remove the clutch, structural damage to the flywheel could occur and could subsequently cause the flywheel to burst).

PARTS COVERED

Listed below are the parts covered by the Federal Emission Design and Defect Warranty. Some parts listed below may require scheduled maintenance and are warranted up to the first scheduled replacement of that part. The warranted parts include:

1. Carburetor Internal Components
 - Valve Assembly-throttle, Jet, Metering Diaphragm
2. Ignition System Components
 - Ignition Coil
 - Flywheel Rotor

The emission control system for your particular Shindaiwa engine may also include certain related hoses and connectors.

LIMITATIONS

The Federal Emission Design and Defect Warranty shall not cover any of the following:

- (a) conditions resulting from tampering, misuse, improper adjustment (unless they were made by the dealer or service center authorized by Shindaiwa Kogyo Co., Ltd. during a warranty repair), alteration, accident, failure to use the recommended fuel and oil, or not performing required maintenance services,
- (b) the replacement parts used for required maintenance services,
- (c) consequential parts used for required maintenance services,
- (d) diagnosis and inspection fees that do not result in eligible warranty service being performed, and
- (e) any non-authorized replacement part, or malfunction of authorized parts due to use of non-authorized parts.

MAINTENANCE AND REPAIR REQUIREMENTS

You are responsible for the proper use and maintenance of the engine. You should keep all receipts and maintenance records covering the performance of regular maintenance in the event questions arise. These receipts and maintenance records should be transferred to each subsequent owner of the engine. Shindaiwa Kogyo Co., Ltd. reserves the right to deny warranty coverage if the owner has not properly maintained the engine. Shindaiwa Kogyo Co., Ltd. will not deny warranty repairs, however, solely because of the lack of repair, maintenance or failure to keep maintenance records.

The following statement only applies to United States and its territories

Shindaiwa Kogyo Co., Ltd.

Federal Emission Design And Defect Limited Warranty Utility And Lawn And Garden Engines

Shindaiwa Kogyo Co., Ltd. warrants to the initial purchaser and each subsequent owner, that this utility equipment engine (herein engine) is designed, built and equipped to conform at the time of initial sale, to all applicable regulations of the U.S. Environmental Protection Agency (EPA), and that the engine is free of defects in materials and workmanship that would cause this engine to fail to conform with EPA regulations during its warranty period. This emission warranty is applicable in all States, except the State of California.

For parts listed under PARTS COVERED, the dealer authorized by Shindaiwa Kogyo Co., Ltd. will, at no cost to you, make the necessary diagnosis, repair, or replacement of any defective emission-related component to ensure that the engine complies with applicable U.S. EPA regulations.

MANUFACTURERS WARRANTY COVERAGE

When sold within the U.S., this engine's emission control system is warranted for a period of two (2) years from the date this product is first delivered to the original retail purchaser.

OWNER'S WARRANTY RESPONSIBILITIES

As the engine owner, you are responsible for the performance of the required maintenance listed in your owner's manual. Shindaiwa Kogyo Co., Ltd. recommends that you retain all receipts covering maintenance on your engine, but Shindaiwa Kogyo Co., Ltd. cannot deny a warranty claim solely for the lack of receipts or for your failure to ensure the performance of all scheduled maintenance.

As the engine owner, you should however be aware that Shindaiwa Kogyo Co., Ltd. may deny your warranty coverage if your engine or a part has failed due to abuse, neglect, improper maintenance or unapproved modifications.

You are responsible for presenting your engine to the nearest dealer authorized by Shindaiwa Kogyo Co., Ltd. when a problem exists.

If your Shindaiwa Dealer is unable to answer questions regarding your warranty rights and responsibilities, you should then contact your Shindaiwa Distributor.

For the name and telephone number of the Shindaiwa Distributor in your area, please call Shindaiwa Inc. at (503) 692-3070 between the hours of 8:00 AM and 5:00 PM Pacific Standard Time.

Product Description

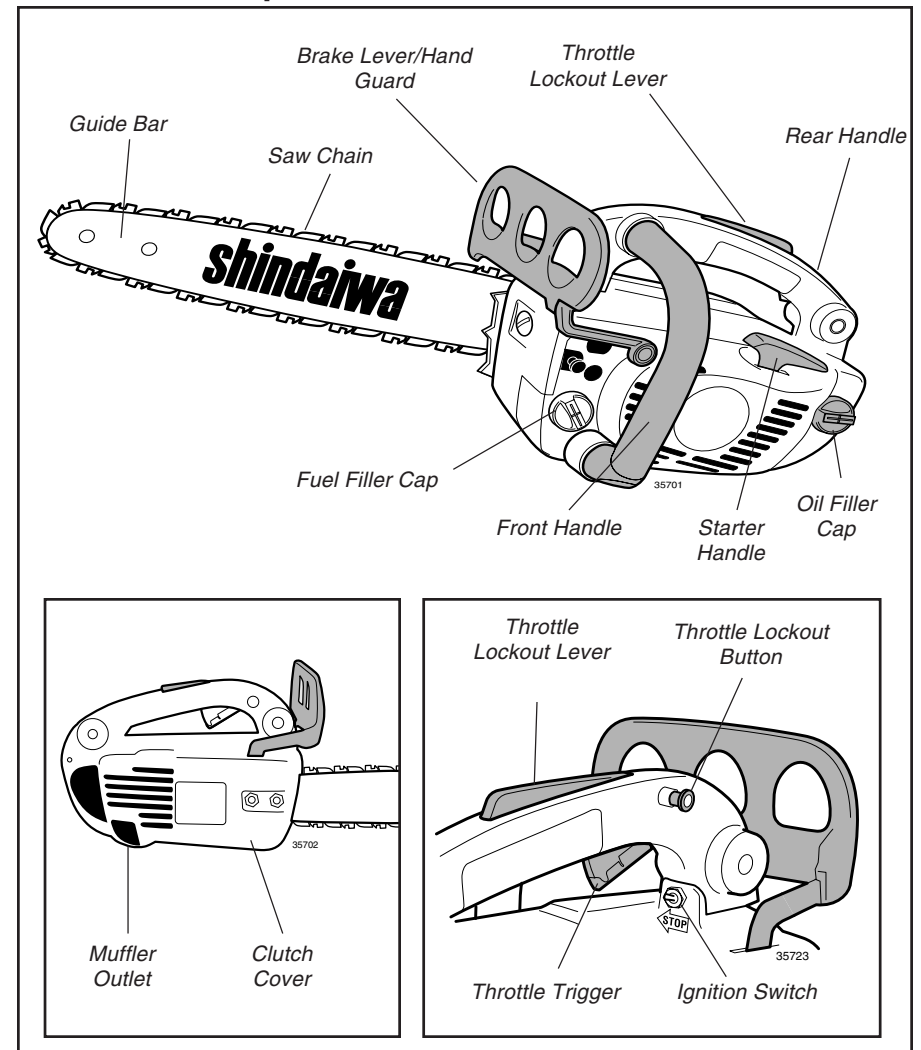

IMPORTANT!

The operational procedures described in this manual are intended to help you get the most from your machine and also to protect you and others from harm. These procedures are general guidelines only, and are not intended to replace any safety rules/laws that may be in force in your area.

If you have any questions regarding your 357 chainsaw, or if you do not understand something in this manual, your Shindaiwa dealer will be glad to assist you.

Specifications

Model	357
Engine Type	2 cycle air cooled gas engine
Displacement	35.5 cc (2.17 cu.in.)
Fuel	Gasoline-Oil Mixture—50:1 with Shindaiwa 2-cycle Mixing Oil
Carburetor	Diaphragm (WALBRO Model WT)
Ignition	All transistor electronic ignition system
Spark Plug	Champion CJ6Y
.....	For EMC compliance use NGK BPMR7A
Starting	Auto-rewind
Stopping	Grounding (toggle switch)
Power transmission	Automatic centrifugal clutch
Chain lubrication	Automatic clutch-driven oiler
Chain	3/8" pitch, gauge 0.050"
Chain oil	Shindaiwa brand premium Bar and Chain Oil (or equivalent)
Fuel tank capacity	265 ml (9.0 oz)
Oil tank capacity	210 ml (7.1 oz)
Front/Rear Handles	Special anti-vibration mountings
Cooling system	Forced air
Safety devices	Front guard, throttle lock, chain catcher and inertial brake
Weight (less bar and chain)	4.2 kg (9.3 lbs)

Tools Included

- Screwdriver
- Spark plug/13 mm socket wrench
- 4 mm hex wrench
- 5 mm hex wrench



WARNING!

Do not make unauthorized modifications to this saw, guide bar, or chain!

RECOMMENDED BAR AND CHAIN COMBINATIONS

Size	Chain	Part Number	Bar
12-inch	Oregon® 91 VG-45X	36120-12	
14-inch	Oregon® 91 VG-53X	36349-14	
16-inch	Oregon® 91 VG-57X	36450-16	



WARNING!

Replacement chain for this saw must meet applicable ANSI B175.1-2000 kickback performance requirements, and/or be designated as "low kickback chain" per ANSI B175.1-2000 standards.

Troubleshooting

ADDITIONAL PROBLEMS

Symptom	Possible Cause	Remedy
Poor acceleration.	Clogged air cleaner.	Clean the air cleaner element.
	Clogged fuel filter.	Replace the fuel filter.
	Chain brake engaged	Inspect and/or test brake. Consult with an authorized servicing dealer.
	Carburetor mixture too rich or too lean.	Adjust carburetor.
	Idle speed set too low.	Adjust: 2,600-3,000 RPM (min ⁻¹)
	Spark arrester clogged	Clean spark arrester. (See page 29).
Engine stops abruptly.	Switch turned off.	Set the switch to "I" (ON), re-start.
	Fuel tank empty.	Refuel.
	Clogged fuel filter.	Clean or replace filter as required.
	Water in the fuel.	Drain; replace with clean fuel.
	Shorted spark plug or loose terminal.	Clean and replace spark plug. Tighten the terminal.
	Ignition failure.	Consult with an authorized servicing dealer.
	Piston seizure.	Consult with an authorized servicing dealer.
Engine difficult to shut off.	Ground (stop) wire is disconnected, or switch is defective.	Test and replace as required.
	Overheating due to incorrect spark plug.	Correct plug: Champion CJ6Y. For EMC compliance use NGK BPMR 7A
	Overheated engine.	Idle engine until cool.
Chain rotates at idle speed.	Engine idle too high.	Set idle: 2,600-3,000 RPM (min ⁻¹).
	Broken clutch spring or shoe.	Replace spring/shoes as required.
Excessive vibration.	Worn or damaged sprocket, chain or bar.	Inspect and replace chain components as required.
	Bent crankshaft.	Consult with an authorized servicing dealer.

Troubleshooting

LOW POWER OUTPUT

What To Check

Possible Cause

Remedy

Is the engine overheating?	Operator is overworking the machine.	Cut at a slower rate. Sharpen the chain as required.
	Carburetor mixture is too lean.	Adjust the carburetor.
	Improper fuel ratio.	Re-fill with fresh fuel of the correct mixture (gasoline and Shindaiwa 2-cycle Mixing Oil, 50:1 ratio).
	Fan, fan cover, cylinder fins dirty or damaged.	Clean, repair or replace as necessary.
Engine is rough at all speeds. May also have black smoke and/or unburned fuel at the exhaust.	Clogged air cleaner.	Service the air cleaner.
	Loose or damaged spark plug.	Tighten or replace.
	Air leakage or clogged fuel line.	Repair or replace filter and/or fuel line.
	Water in the fuel.	Replace the fuel.
	Piston seizure.	Consult with an authorized servicing dealer.
	Faulty carburetor and/or diaphragm.	Consult with an authorized servicing dealer.
	Carbon deposits on the piston or in the muffler.	Consult with an authorized servicing dealer.
Engine is knocking.	Overheating condition.	See above.
	Improper fuel.	Check fuel octane rating; check for presence of alcohol in the fuel. Refuel as necessary.
	Carbon deposits in the combustion chamber.	Consult with an authorized servicing dealer.

Kickback Safety

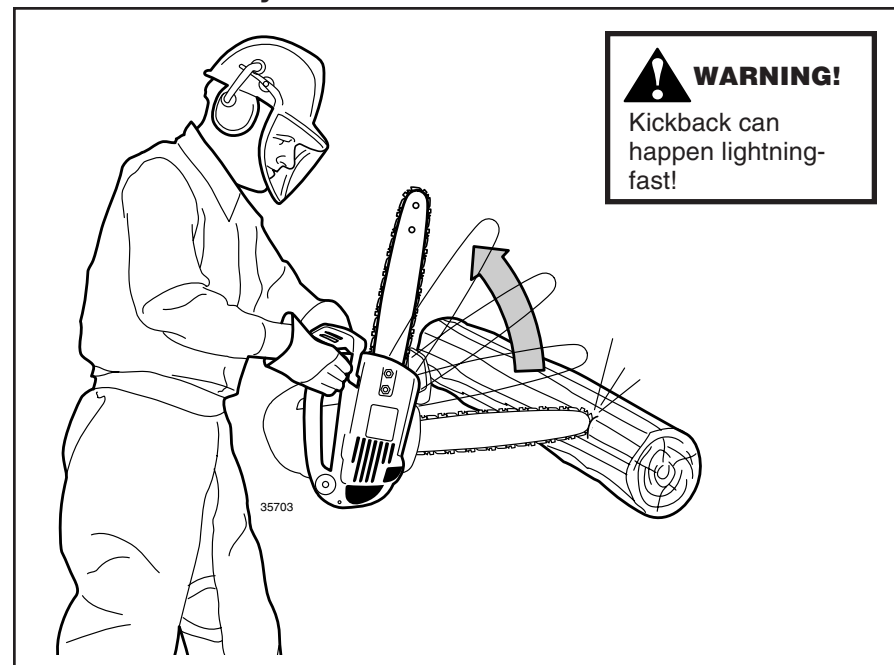

This saw is equipped with the following safety equipment:

- Operator activated and Inertial type chain brake.** In the event of kickback, kickback energy either forces the brake lever against the operator's hand when the saw is held as illustrated above activating the chain brake and/or inertia causes chain brake activation. When the brake is activated, a spring-loaded brake band is applied against the chain drive mechanism, stopping the chain rotation.

- “Low kick” chain.** When used in combination with the appropriate guide bar, low kick chain significantly reduces the effects of kickback.



WARNING!

To reduce the risk of kickback, all of the above devices must be properly installed and in good repair. Use of other than ANSI B175.1-2000 bar and chain combinations may result in reduced kickback protection!



WARNING!

Brake engagement and operation depends upon proper inspection and maintenance procedures! For correct procedures, see page 21.



WARNING!

Never operate this or any other chain saw with only one hand! One-handed operation could cause serious injury to the operator, helper, or any nearby observers! A chain saw is intended for two-handed operation!

Kickback Safety Precautions



WARNING!

Either of the following reactions could cause you to lose control of your saw while cutting, possibly resulting in serious injury!

1. Kickback can occur whenever the guide bar nose or tip contact an object while the saw is running. Tip contact may cause the guide bar to kick upward and back toward the operator, with a lightning-fast reaction!
2. Pinching the saw along the top of the guide bar may push the guide bar rapidly back toward the operator! Pinching can occur whenever wood closes in around the moving chain!

Do not rely exclusively on the safety devices incorporated with your saw. As a chain saw user, observing the following steps will also help you to avoid accident or injury on the job:

- Sudden surprise can contribute to accidents! With a basic understanding of kickback, you can reduce or eliminate the element of surprise.
- Clear obstructions from the work area before cutting. Remove any log, branch, or other obstruction that might contact the guide bar tip during cutting operations.
- Grip the saw firmly with your right hand on the rear handle and your left hand on the front handle, thumbs and fingers encircling the handles, whenever the saw is running. Don't let go: A firm grip will help you to reduce kickback while maintaining control of the saw.
- Accelerate the saw before the chain contacts the work area, and always maintain high engine speeds throughout the cut.
- Do not overreach or attempt to cut above shoulder height.
- Follow the manufacturer's instructions for sharpening and maintenance of the saw chain.
- Use only the replacement bar and chain combinations specified by the manufacturer.
- Never stand directly over the saw while cutting!
- Use low-kickback chain, chain brakes, or special guide bars to reduce the risk of kickback. Low kickback chain is chain that has met the kickback performance requirements of ANSI B175.1-2000 (American National Standard for Power Tools-Gasoline Powered Chain Saws-Safety requirements) when tested on the representative sample of chain saws below 3.8 c.i.d. specified in ANSI B175.1-2000.

Troubleshooting

ENGINE DOES NOT START

What To Check	Possible Cause	Remedy
Does the engine crank?	NO → Faulty recoil starter. Fluid in the crankcase. Internal damage.	Consult with an authorized servicing dealer.
YES ↓		
Good compression?	NO → Loose spark plug. Excess wear on cylinder, piston, rings.	Tighten and re-test. Consult with an authorized servicing dealer.
YES ↓		
Does the tank contain fresh fuel of the proper grade?	NO → Stale, or contaminated fuel mixture.	Re-fill with fresh fuel of the correct mixture (gasoline and Shindaiwa 2-cycle Mixing Oil at a 50:1 ratio).
YES ↓		
Is fuel reaching the cylinder and combustion chamber?	NO → Check for clogged fuel filter and/or vent.	Clean as required; restart.
YES ↓		
Is there spark at the spark plug wire terminal?	NO → Is the ignition switch ON? Faulty ignition ground. Faulty ignition unit.	Move switch to "I" (ON) position and re-start. Consult with an authorized servicing dealer.
YES ↓		
Check the spark plug.	→ If the plug is wet, excess fuel may be in the cylinder. The plug is fouled or improperly gapped. The plug is damaged internally or of the wrong size.	Crank the engine with the plug removed, replace the plug, and re-start. Clean and re-gap the plug to 0.024 inch (0.6 mm). Re-start. Replace the plug with a Champion CJ6Y. Re-start. For EMC compliance use NGK BPMR 7A

Sharpening the Chain (cont.)

Correct Filing Technique

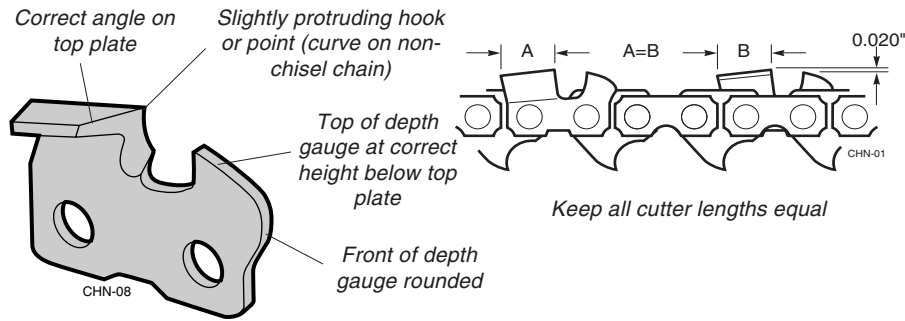

Filing Problems

Top plate angle less than recommended

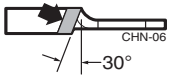

Cause
File held at less than recommended angle.

Result
Slow cutting. Requires extra effort to cut.

Remedy
File cutters to recommended angle.

Top plate angle more than recommended

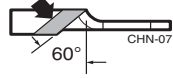

Cause
File held at more than recommended angle.

Result
Cutting angle is very sharp but will dull fast. Cutting action rough and erratic.

Remedy
File cutters to recommended angle.

Hook in side plate cutting edge

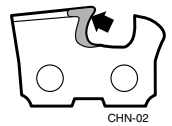

Cause
File held too low or the file was too small.

Result
Rough cutting. Chain grabs. Cutters dull quickly or won't hold a cutting edge.

Remedy
File cutters at recommended angle. Check file size.

Backslope on side plate cutting edge

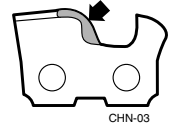

Cause
File held too high or the file was too large.

Result
Cutters won't feed into wood. Slow cutting. Must force chain to cut. Causes excessive bottom wear.

Remedy
File cutters at recommended angle. Check file size.

High depth gauge

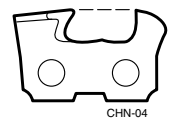

Cause
Depth gauge never filed.

Result
Slow cutting. Must force chain to cut. Will cause excessive wear on the cutter heel.

Remedy
Lower gauges to recommended setting.

Low depth gauge

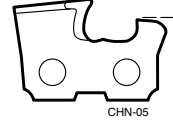

Cause
Wrong gauge setting or no gauge used.

Result
Rough cutting. Chain grabs. Saw won't pull chain through wood. Excessive wear on the cutter heel.

Remedy
If depth gauges are too low, the chain is no longer serviceable.

Additional Safety Precautions



WARNING!

NOTE:

These safety precautions are intended primarily for consumers or occasional users. When using this chain saw for logging purposes, refer to: CFR Section 1910.266 (5); 2.5.1 of the American National Safety Standard; Requirements for Pulpwood Logging ANSI 03.1-1978; and any applicable state safety codes.

- Never operate this chain saw with one hand! One-handed operation could cause you to lose control, causing serious injury to yourself or others! A chain saw is intended for two-handed use.
- Wear safety footwear, snug-fitting clothing, protective gloves, and eye, hearing, and head-protection devices while working with this chain saw.
- Do not allow other persons to be near the chain saw when starting or running the chain saw. Keep bystanders and animals out of the work area.
- Never allow young children or any person unfamiliar with chain saws to operate this saw!
- Clear the work area before using the saw. Never start cutting until you are sure you have a secure footing and have planned a retreat path from the falling tree.
- Before starting the saw engine, make sure nothing is touching the saw chain.
- Keep all parts of your body away from the saw chain whenever the engine is running!
- Stop the engine before carrying the saw. Carry the saw with the engine stopped, the guide bar and saw chain pointing to the rear, and the engine muffler away from your body.
- Never operate this chain saw if you are fatigued.
- Stop the engine before setting the chain saw down.

Additional Safety Precautions (cont.)

**WARNING!**

- Install the appropriate guide-bar scabbard before transporting the saw.
- Never operate a saw that is damaged, improperly adjusted, or not completely and securely assembled.
- Use only Shindaiwa-recommended parts when repairing or servicing this saw.
- Do not use this saw if the saw chain continues to move after the throttle control trigger is released.
- Use extra care when cutting a limb that is under tension! A limb under tension could spring back suddenly, causing you to lose control of the saw!
- Use extreme caution when cutting smaller brush and saplings! Small-diameter material may catch in the chain and be whipped toward you or pull you off balance, causing you to lose control of the saw!
- Operate the saw only in a well ventilated area.
- Keep the saw handles dry, clean and free of oil or fuel mixture.
- Never operate any saw while in a tree unless you have been specifically trained to do so!
- Never perform service or repairs to this saw unless you are specifically trained and equipped to do so!
- Improper maintenance, use of nonconforming replacement components, or the removal of safety devices, such as the chain brake or any of the chain brake components, could result in serious injury.
- Never allow any part of your body near the clutch cover of an operating saw.
- Never operate a saw with damaged or missing anti-vibration cushions. Long-term exposure to vibration can damage your hands.
- Always maintain a firm footing while operating this saw! Ladders and other temporary platforms can shift unexpectedly, and are not recommended!

Sharpening the Chain

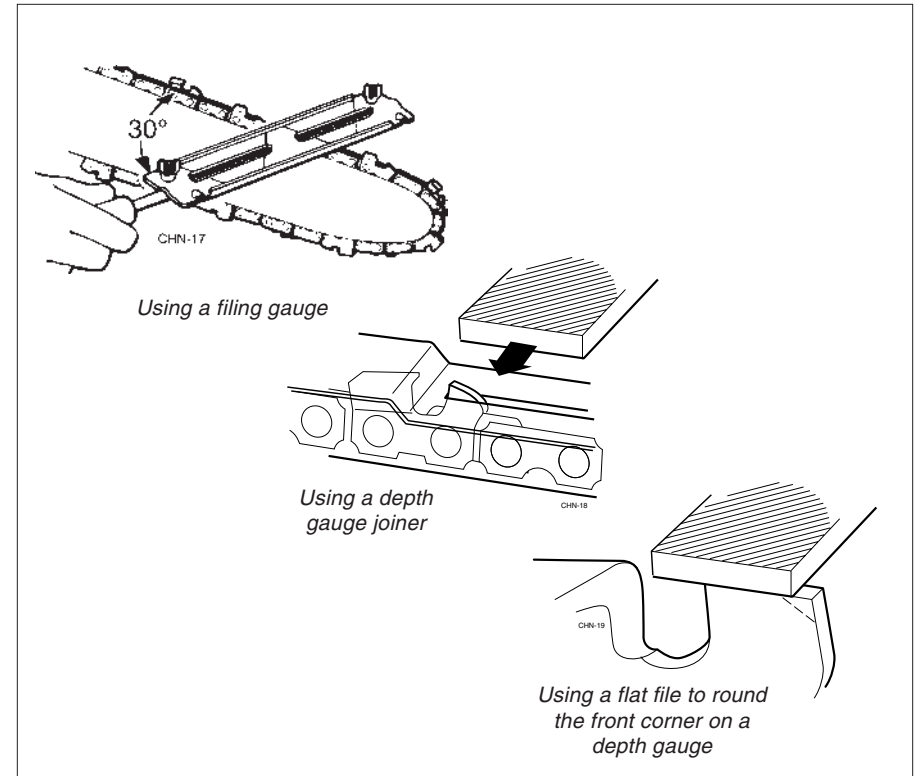
**Sharpening Technique**

1. Using a 5/32" round file, sharpen all cutters to a 30° angle .
2. After all cutters are sharpened, use a depth gauge joiner (Oregon® p/n 106738 or equivalent) to measure the height of each depth gauge.

IMPORTANT!

File all cutters to the same angle and depth! Unequal filing may cause the saw to vibrate or cut erratically!

NOTE:

For consistent filing angles, use a filing guide such as Oregon® p/n 37534 or equivalent.

3. As required, lower the depth gauges to a height of 0.020" (0.5 mm). Use a flat file; Oregon® p/n 12211 or equivalent.
4. After all depth gauges have been adjusted, use a flat file to round each depth gauge leading edge to its original curvature and angle.

Saw Chain

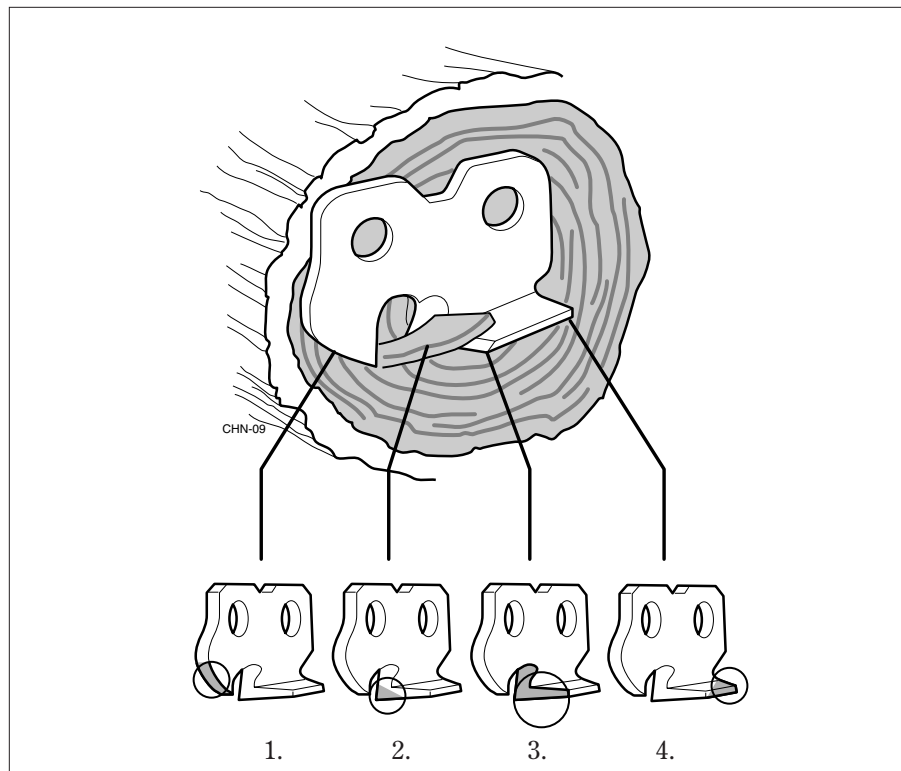

Your saw's performance on the job depends greatly on the condition of its saw chain.

How the saw chain works

As the chain is pulled through the wood:

1. The depth gauge determines the depth of cut for the cutter.
2. The cutter's leading edge enters the wood, causing the entire cutter to "rock back" and lift away from the bar.

3. The top plate peels the severed wood chip away.
4. The chip is discharged out the rear of the cutter.

IMPORTANT!

Most of the actual cutting is done by the sides and corners of the individual cutters.

Installing and Adjusting the Guide Bar and Saw Chain

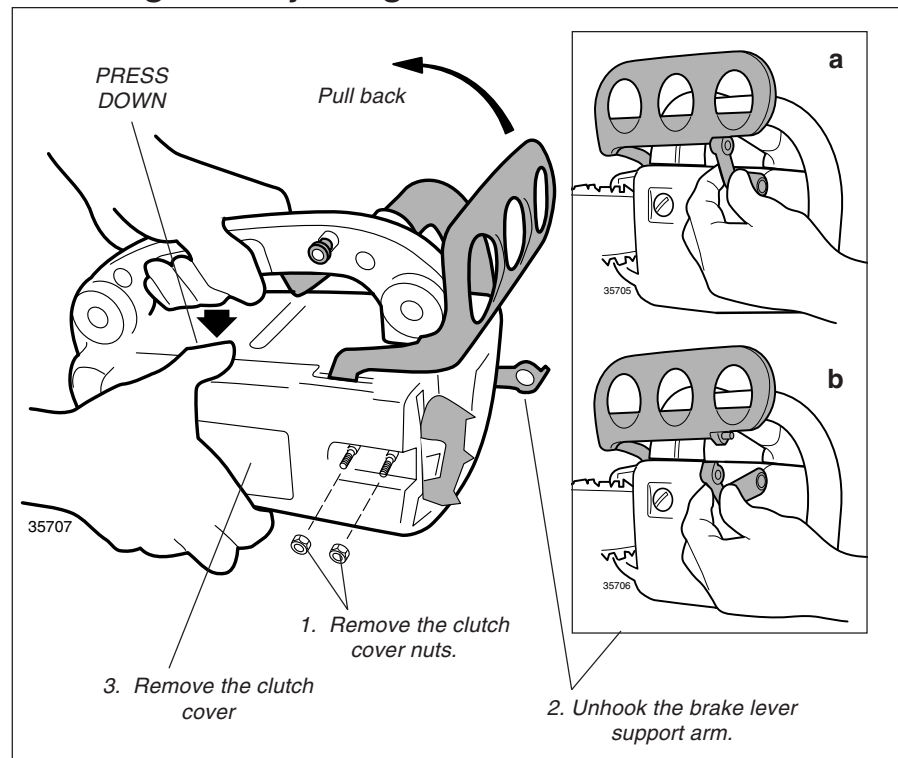

IMPORTANT!

The chain brake must be completely disengaged before removing or installing the clutch cover!

1. Use the 13 mm socket wrench to remove the clutch cover nuts. Turn the nuts counter-clockwise to remove.
2. Slide the rubber stopper downward and unhook the support arm from the brake lever (see illustration below).

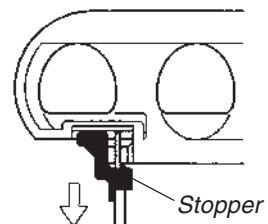

3. Disengage the clutch cover retaining hook by pressing the cover as shown, and then remove the clutch cover.
4. Remove and discard the packing spacer.
5. Place the guide bar over the guide bar studs and chain tensioner pin. If necessary, turn the chain tension screw in or out until the loop slips easily over the guide bar tip.

Continued on next page.

Installing and Adjusting the Guide Bar and Saw Chain

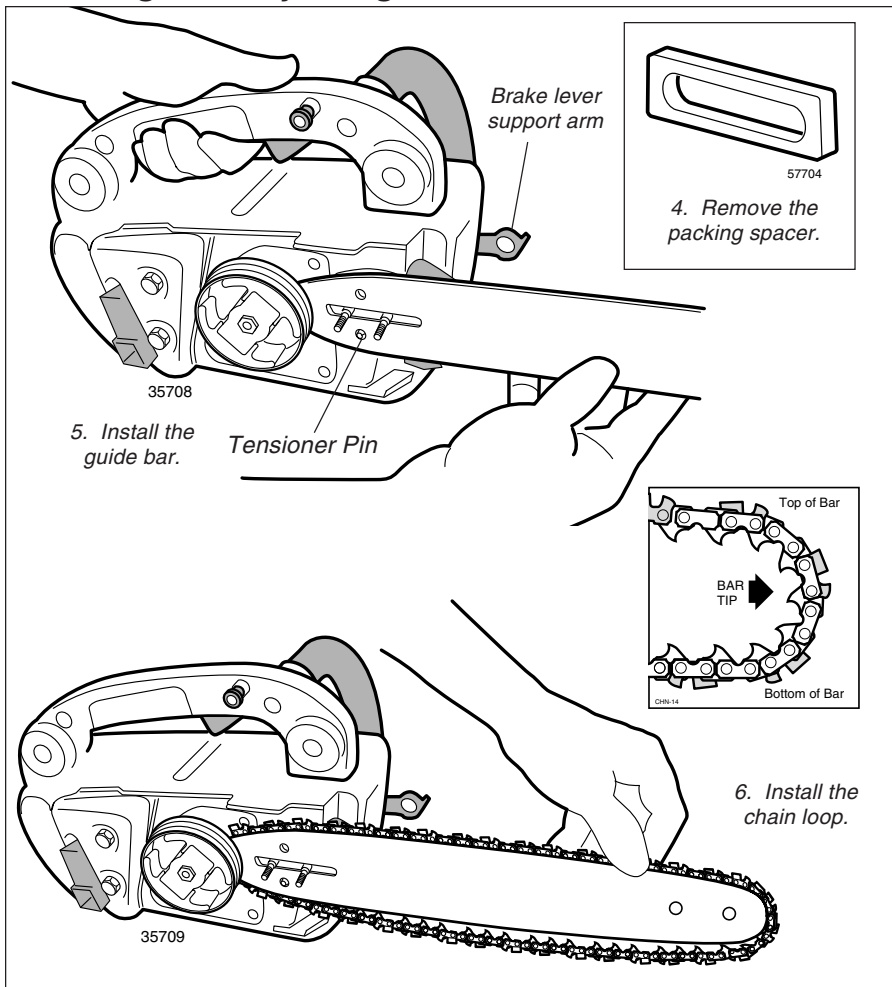

CAUTION!

Failure to align the guide bar and chain tensioner pin as shown can cause serious damage to the clutch cover, guide bar, tensioner pin and/or engine crankcase!

6. Install the chain loop over the drive sprocket, and then align the chain drive links within the guide bar groove. Make sure the cutters are properly oriented.



WARNING!

Never start the engine without the clutch cover installed!

7. Install the clutch cover over the two bar studs, and then engage the brake lever and support arm. Install the two 13 mm bar nuts and tighten finger-tight only.

Spark Arrester

Hard starting or a gradual loss of performance can be caused by carbon deposits lodged in the spark arrester screen. For maximum performance, the spark arrester screen should be periodically cleaned as follows:

1. Unscrew the two clutch cover nuts, and remove the clutch cover (see page 11).
2. Use a screwdriver to remove the two spark arrester retaining screws, and then remove the spark arrester cover and screen.

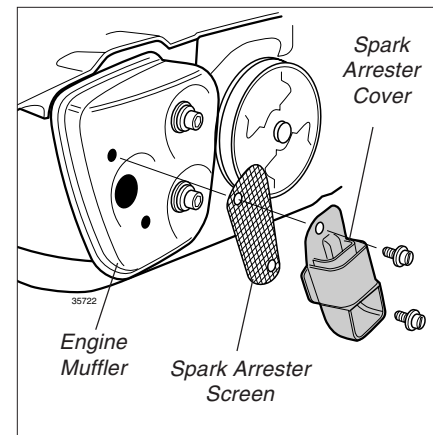

3. Use a plastic scraper or wire brush to remove carbon deposits from the arrester screen and cover.
4. Inspect the screen carefully, and replace any screen that has been perforated, distorted, or is otherwise unserviceable.
5. Install the screen and cover in the reverse order of disassembly, and then tighten the two cover retaining screws securely.
6. Install the clutch cover and cover retaining nuts in the reverse order of removal, and then tighten both nuts securely.

Long Term Storage

(over 30 days)

- Thoroughly clean the saw exterior.
- Remove all chips and other debris from the cylinder fins and cooling passages.
- Drain the fuel tank, and then clear the carburetor and lines by running the saw until it stops from lack of fuel.

CAUTION!

Never store the saw with any fuel remaining in the tank, fuel lines, or carburetor!
Your Shindaiwa warranty does not include coverage for damage caused by "stale" or contaminated fuels!

- Drain any remaining bar oil from the oil reservoir.
- Remove the spark plug, and then pour about 1/4-oz of 2 cycle mixing oil into the cylinder through the spark plug hole. Before reinstalling the spark plug, slowly pull the recoil starter 2 or 3 times to distribute the oil over the cylinder walls.
- Remove, clean, and reinstall the air filter element as described under "Daily Maintenance".
- Repair or replace any damaged components as required, and then store the machine in a clean, dry, dust-free area.

10/15 Hour Maintenance

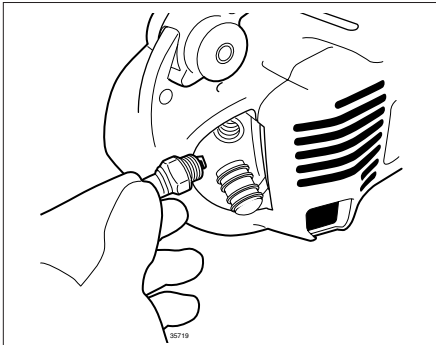

- Remove and clean the spark plug. Adjust the spark plug gap to 0.024" (0.6 mm), and reinstall. If a torque wrench is available, torque the plug to 148–165 in.-lbs. Replace a damaged or visibly worn plug with a Champion CJ6Y or For EMC compliance use NGK BPMR 7A.

CAUTION!

Incorrect spark plug installation can result in serious engine damage!

Never allow chips or other debris to enter the cylinder bore! Before removing the spark plug, thoroughly clean the spark plug and cylinder head area!

- Remove the guide bar and chain. Carefully inspect the drive sprocket for wear or damage, and replace if needed. Inspect the guide bar grooves and tip for wear or damage, and repair or replace components as required.

IMPORTANT!

Always replace the drive sprocket and cutting chain loop as a set! For economy, rotate the same 2 or 3 chains daily. When these chains are worn out, replace both the chains and the sprocket at the same time.

40/50 Hour Maintenance

- Replace the spark plug with a Champion CJ6Y (or equivalent), gapped to 0.024" (0.6 mm). For EMC compliance use NGK BPMR 7A.
- Extract the fuel filter from inside the fuel tank. Remove and wash both filter elements in clean fuel. If you discover damage or deterioration to the fuel lines or other fuel system components, remove the saw from service until it can be inspected by a Shindaiwa-trained service technician.

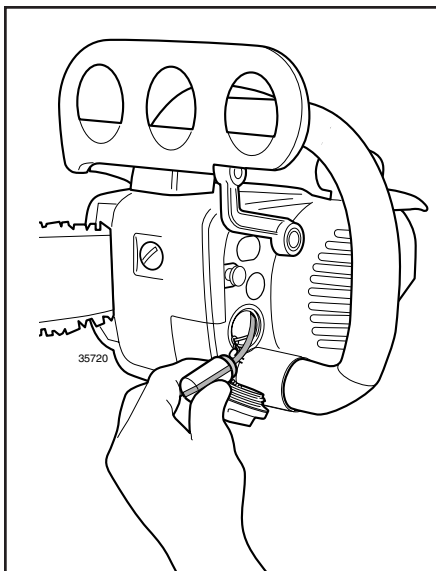

CAUTION!

The fuel line can be punctured or torn by careless handling! Never use sharp or jagged-edged tools to extract the fuel line.

Installing and Adjusting the Guide Bar and Saw Chain

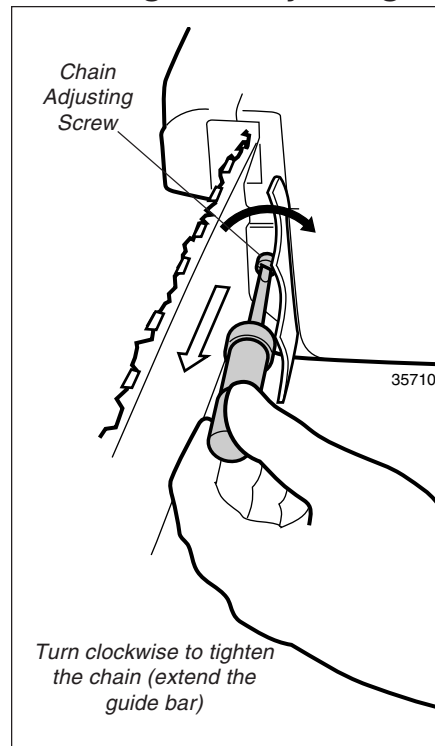

Turn clockwise to tighten the chain (extend the guide bar)

IMPORTANT!

Proper chain adjustment is essential for maximum performance, chain life, and operator safety. Always inspect chain tension before operating the saw!

NOTE:

For longest chain life, place new or replacement chain loops in oil and soak overnight before installation.

- Place the saw on a flat surface, and lift the bar nose slightly.
- To adjust chain tension:
 - turn the chain tension screw clockwise to tighten the chain.
 - turn the chain tension adjuster counter-clockwise to loosen the chain.

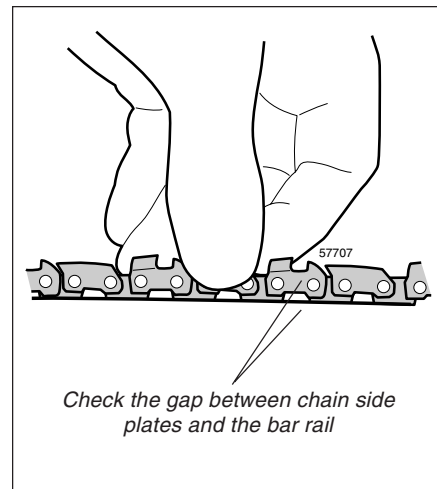

Check the gap between chain side plates and the bar rail

- Hard-nose Guide Bar** Gently lift the chain at about mid-bar. Tension is correct when there is a gap of 3–3.5 mm (about 0.125") between the chain side plates and the bar rail.
- Sprocket-nose Guide Bar** The chain should be adjusted slightly tighter than on a hard-nose bar, but must still pull freely around the bar.

- Tighten both bar nuts securely, making sure chain adjustment is correct for the type of bar installed.

Adjusting Chain Tension in the Field Stop the saw, loosen both bar nuts about 1 turn each, then repeat Steps 8 through 10 (above). Never operate the saw when the chain is loose!



WARNING!

Inspect chain tension often during operation, especially when breaking in a new chain. A loose saw chain can unexpectedly jump the guide bar during operation, possibly causing serious personal injury!

Mixing Fuel/Filling With Fuel



WARNING!

Minimize the risk of fire burns and personal injury!

- STOP engine before refueling.
- ALWAYS allow the engine to cool before refueling!
- ALWAYS open the fuel cap slowly to allow any pressure build-up in the tank to release fuel vapor slowly.
- Wipe all spilled fuel and move the engine at least 10 feet (3 meters) from the fueling point and source before restarting!
- NEVER start or operate this unit if there is a fuel leak.
- NEVER start or operate this unit if the carburetor, fuel lines, fuel tank and/or fuel tank cap are damaged.
- NEVER smoke or light any fires near the engine or fuel source!
- NEVER place any flammable material near the engine muffler!
- NEVER operate the engine without the muffler and spark arrester in good working condition.

IMPORTANT!

Shindaiwa high-performance 2-cycle engines are designed to operate on a 50:1 mixture of unleaded gasoline and 2-cycle engine oil. Using a fuel mixture less than 50:1 ratio (such as 80:1 or 100:1) can cause catastrophic engine failure!

1. Use only fresh, clean unleaded gasoline with a pump octane rating of 87 or higher.
2. Mix fuel with a 2-cycle engine oil designed for use in high-performance 2-cycle air-cooled engines.

CAUTION!

- Some types of gasoline contain alcohol. Never use any type of gasoline containing more than 10% alcohol by volume! More than 10% alcohol by volume may affect the lubricating qualities of 2-cycle engine oils reducing engine life and/or causing engine failure.
- Generic engine oil and marine engine oil may not be intended for use in high-performance 2-cycle engines and should never be used in Shindaiwa engines. Engine oils not intended for use high-performance air-cooled 2-cycle engines can cause excessive carbon deposits, reduce engine life and/or cause engine failure.

NOTE:

Shindaiwa offers two performance levels of 2-cycle air-cooled engine oils, Shindaiwa 2-Cycle Engine Oil and Shindaiwa ONE High Performance 2-Cycle Engine Oil. Shindaiwa 2-Cycle Engine Oil is designed to meet the lubrication demands of most 2-cycle air-cooled engines. Shindaiwa ONE High Performance 2-Cycle Engine Oil is recommended when superior lubrication is needed to help protect engines used in severe operating conditions. Shindaiwa ONE also contains a fuel stabilizer to help maintain fuel quality when fuel is stored longer than 30 days.

Daily Maintenance

IMPORTANT!

MAINTENANCE, REPLACEMENT, OR REPAIR OF EMISSION CONTROL DEVICES AND SYSTEM MAY BE PERFORMED BY ANY REPAIR ESTABLISHMENT OR INDIVIDUAL. HOWEVER, WARRANTY REPAIRS MUST BE PERFORMED BY A DEALER OR SERVICE CENTER AUTHORIZED BY SHINDAIWA KOGYO, LTD. AND USE OF PARTS THAT ARE NOT EQUIVALENT IN PERFORMANCE AND DURABILITY TO AUTHORIZED PARTS MAY IMPAIR THE EFFECTIVENESS OF THE EMISSION CONTROL SYSTEM AND MAY HAVE A BEARING ON THE OUTCOME OF THE WARRANTY CLAIM.



WARNING!

Before performing any maintenance on this saw, stop the engine and disconnect the spark plug wire!

- Remove dirt and debris from the saw exterior, cylinder fins, and cooling air intake.
- Inspect the saw for fuel and oil leaks. Repair as necessary.

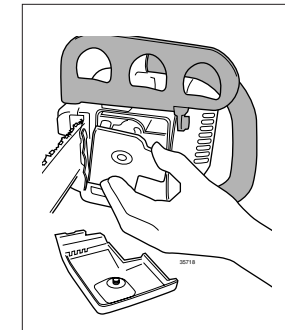

- Remove the air cleaner cover and element. Wash both parts with soap and water. Let dry before reassembly.

CAUTION!

Never allow chips or other debris to enter the carburetor bore! Avoid forcing dirt into the air filter element! When using compressed air to dry the element, blow only on the inside (carburetor side) face of the element!

- Sharpen and adjust the chain as required.
- Clean the guide bar groove and oil hole. Inspect the bar groove and tip for damage or unusual wear. Repair or replace components as necessary.
- Inspect the entire saw for damage, including loose or missing components or fastenings. Repair as necessary.

Bucking



WARNING!

Always cut downed timber from the *uphill* side of the tree!
Downed timber may shift or roll unpredictably during cutting or handling. Be alert for potential injury from rolling or shifting logs!

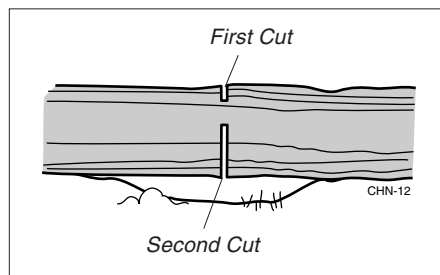

If the log is well supported, start your cut from the top of the log. Keeping the guide bar parallel to the ground, cut straight down but do not allow the saw to cut into the ground.

NOTE:

Cutting downed timber, or "bucking," increases the possibility of the wood settling and pinching the guide bar. Driving one or more soft plastic or wooden bucking wedges can help prevent bar-pinching during a cut.

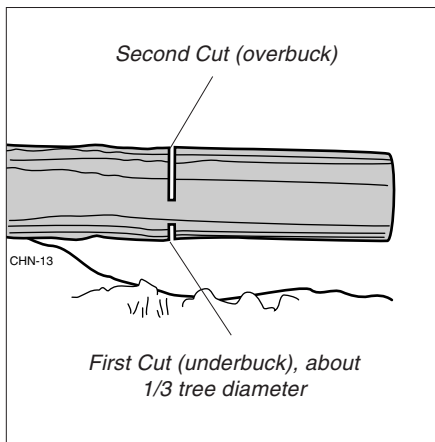

Use two cuts when bucking the outboard end of an unsupported log. Your first cut should be an underbuck. Cut the underbuck about 1/3 the diameter of the tree, then move to the top of the log and finish the cut by bucking down (overbucking) to the first cut.

NOTE:

When cutting unsupported logs or limbs, starting with an underbuck cut will minimize the possibility of the wood splitting during the bucking cut.

Use two cuts when bucking near the inboard end of an unsupported log.

- Make the first cut as an underbuck about 1/3 the diameter of the log.
- Finish the job from above with an overbuck joining the first cut.



WARNING!

Do not overreach or attempt to cut above shoulder height!

Mixing Fuel/Filling With Fuel (cont.)

3. Refer to following chart for examples of 50:1 fuel to oil mix quantities.
4. Place the saw on a hard surface with the fuel cap up and wipe any chips or debris from around the fuel cap.
5. Remove the fuel cap and fill the tank with clean, fresh 2-cycle fuel mix. Avoid overfilling and fuel spillage.
6. Wipe any spilled fuel and move the saw at least 10 feet (3 meters) from the fueling point before starting the engine.

Gasoline U.S. Gal.	2-cycle oil U.S. fl. oz.	Gasoline liters	2-Cycle Oil milliliters
1 gal.	2.6 oz.	2.5 l.	50 ml
2 gal.	5.2 oz.	5 l.	100 ml
2.5 gal.	6.4 oz.	10 l.	200 ml
5 gal.	12.8 oz.	20 l.	400 ml

Bar Oil/Filling With Oil

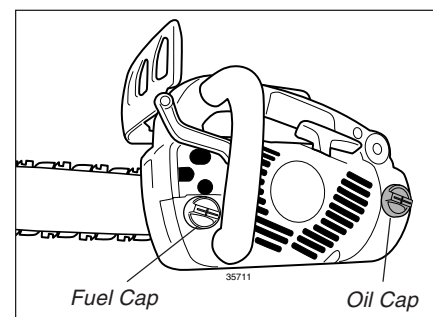

Oil Requirements

- When available, use Shindaiwa Premium bar & chain oil.
- When Shindaiwa oil is not available, use a premium 30-weight oil specifically blended for bar & chain lubrication.
- For cold weather operation, bar oil may be thinned by mixing with clean kerosene at a ratio of 1:1.

Filling the Oil Reservoir

- Filling the Oil Reservoir Place the saw on its side (clutch cover down), and wipe any chips or debris from around the oil cap.
- Remove the oil cap at the front of the saw.
- Fill the oil reservoir with bar & chain oil, and replace the cap.
- Wipe spilled oil from handles and controls before starting the saw.

CAUTION!

Proper lubrication is critical to the performance and service life of your saw's oil pump, guide bar, and saw chain! Always use a high quality lubricating oil designed for saw chain lubrication! Never use dirty or re-claimed oil!

LIMBING

Limbing a standing tree is usually accomplished in the same manner as bucking, with a third and final cut used to remove the remaining stub of the limb.

Preparing to Start the Saw

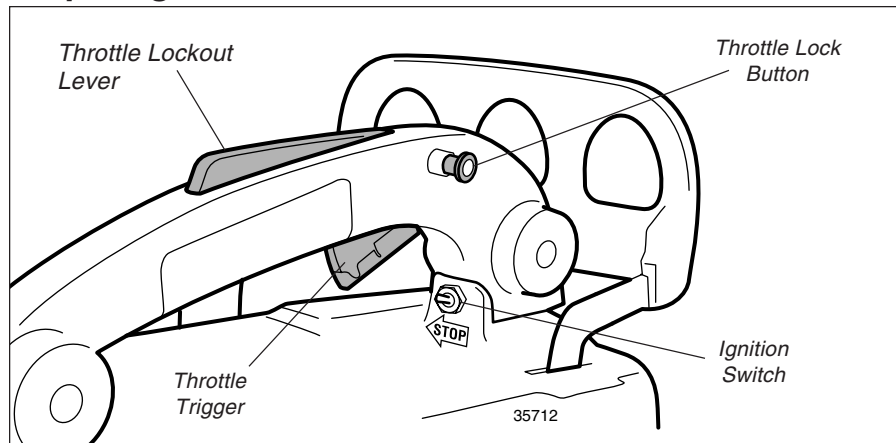

WARNING!

The saw chain will rotate when the saw is started! Clear a safe work area before starting the saw!

IMPORTANT!

Engine ignition is controlled by a two-position "ON-OFF" switch located below the throttle lever. This switch is labeled "I" for ON and "O" for OFF.

Control Positions (cold engine)

1. Switch the ignition ON ("I" position).
2. Choke the engine by pulling the choke control all the way out (choke is closed).
3. Set the throttle to "fast idle" by performing the following:
 - Depress the throttle lockout lever.
 - Squeeze the throttle trigger.
 - Press and hold the throttle lock button while releasing the throttle trigger.

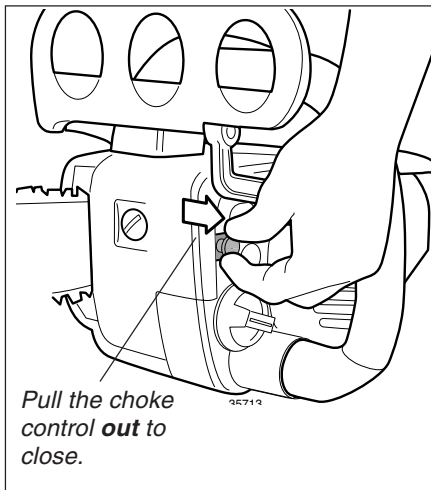

Control Positions (warm engine)

- Set the throttle to "fast idle" (as described in step 3).

IMPORTANT!

The throttle lever cannot be moved without first depressing the lockout lever.

Felling Trees (cont.)

Felling Small Trees

(less than 6 inches in diameter)

1. Determine the direction of fall. If you are uncertain as to direction of fall, use the procedure "Felling Large Trees".
2. Start cutting on the side of the tree away from the direction of fall, and make a single felling cut all the way through the tree.
3. Stop the saw and put it down on the ground.
4. Use your retreat path to exit the area quickly.

Felling Large Trees

(more than 6 inches in diameter)

If a tree is otherwise healthy and not seriously out of balance, its direction of fall can often be encouraged by first "notching" the tree on the side facing the desired direction of fall.

After the notch is completed, start the felling cut slightly higher and on the opposite side of the tree, away from the direction of fall.

The goal of this method is to leave a sturdy wooden "hinge" on which the tree will pivot while it's falling.

1. Determine the direction of fall.
2. On the side of the tree facing the direction of fall, make a single 90° cut through about 1/3 the tree's diameter.
3. Make a second cut at a 45° angle to the first cut to remove a notch from the tree.
4. Make the final felling cut on the opposite side of the tree about 2 inches above the bottom of the notch.

NOTE:

If the felling cut appears to be closing on the bar, use a mallet to drive one or two plastic or wooden wedges into the cut behind the bar.

5. Stop the saw, and put it down.
6. Use your retreat path to exit the area quickly.



WARNING

Failure to leave a wooden hinge during the felling or "back cut" can cause the tree to pinch the saw's guide bar, and may also change the direction of fall!

Always make the felling cut parallel to the bottom cut! An angled felling cut may cause the tree to split, possibly changing the direction of fall!

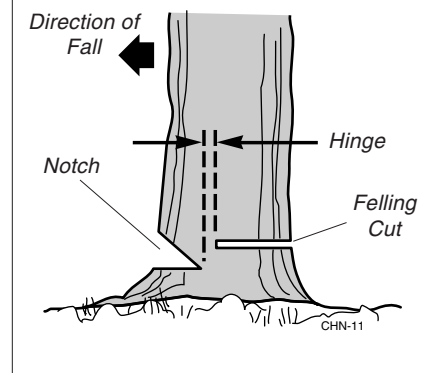

Felling Large Trees

Felling Trees

NOTE:

The Shindaiwa 357 Chain Saw is equipped with a sliding trigger extension to improve comfort when operating the saw in a variety of hand grip positions. When not needed, keep the extension retracted.

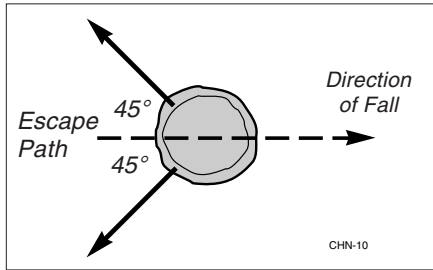
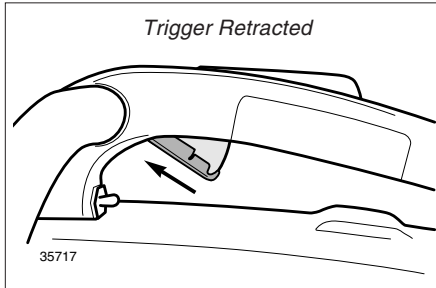
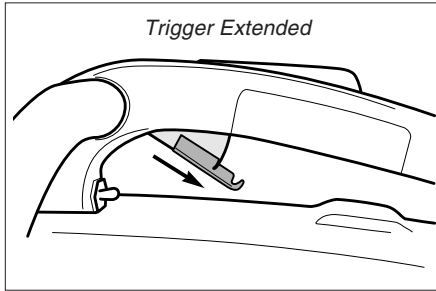

Before Felling a Tree

1. Determine the direction of fall by inspecting:
 - Tree shape and angle of lean.
 - Size, shape and placement of limbs.
 - Location of nearby trees or other obstacles.
 - Condition of the tree (damage, disease, etc.).
 - Prevailing wind direction.
2. Clear a safe work area around the tree. Be alert for loose or dead limbs overhead. Clear an appropriate escape path approximately 45° from the direction of fall.
3. Notify nearby workers of your intentions!

Starting the Saw

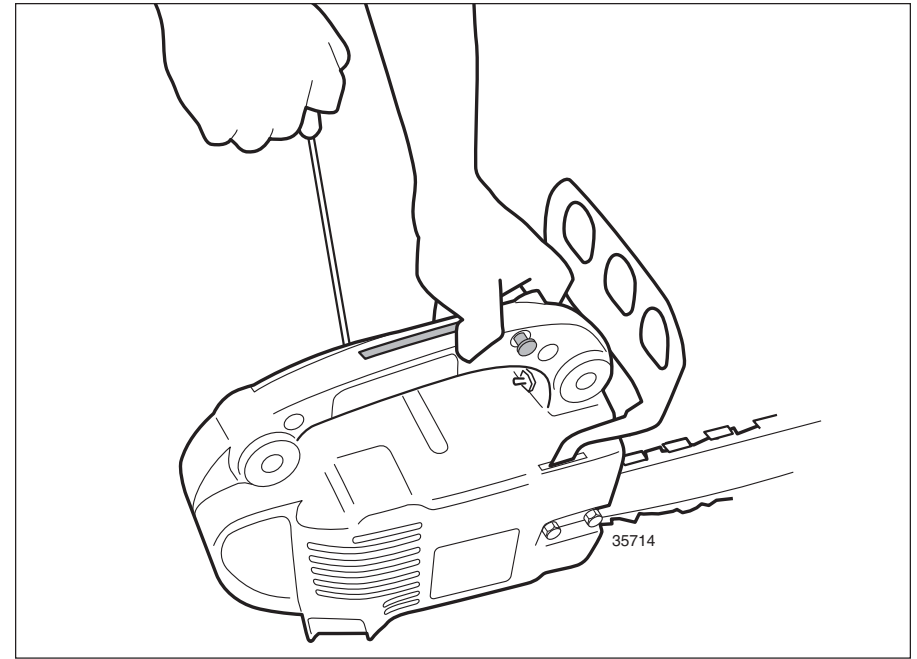

1. Place the saw on the ground.
2. Secure the saw firmly as shown.
3. Grip the starter handle with your right hand, pull the starter cord slowly until you feel the starter engage, then...
4. Start the saw by pulling the starter cord upward rapidly.

When the engine starts:

1. Push the choke control all the way in (choke is open).
2. If the engine did not continue to run, pull the recoil again.
3. As the engine starts, clear excess fuel from the combustion area by revving the engine several times.

CAUTION!

The recoil starter can be easily damaged by abuse!

- **Never** pull the starter cord to its full length.
- **Always** engage the starter before cranking the engine.
- **Always** rewind the starter cord slowly.



WARNING!

The saw chain will move as the engine accelerates!

4. Operating the throttle will automatically disengage the fast-idle setting.

If the engine does not start:

Repeat the appropriate starting procedure for a hot or cold engine. If the engine still will not start, follow the "Starting a Flooded Engine" procedure (next page).

Starting a Flooded Engine

1. Disconnect the spark plug lead, then use the spark plug wrench to remove the spark plug (turn counter-clockwise to remove).
2. If the spark plug is fouled or is soaked with fuel, clean or replace the plug as required. For correct spark plug size and gapping procedure, see page 26.
3. Clear excess fuel from the combustion chamber by cranking the engine several times while the spark plug is removed.
4. Replace the spark plug and tighten it firmly with the spark plug wrench. If a torque wrench is available, torque the spark plug to 140–165 inch-pounds (170–190 kgf • cm).

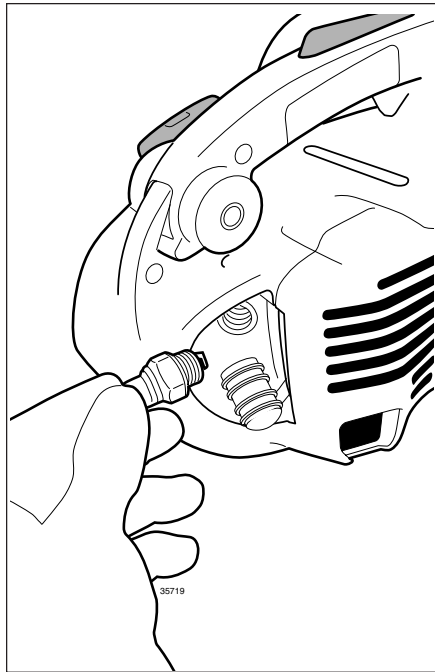

CAUTION!

Incorrect spark plug installation can result in serious engine damage!

5. Repeat the starting procedure for a warm engine.
6. If the engine still fails to fire or start, refer to the troubleshooting chart at the end of this manual.

Stopping

Turn the switch "OFF" after idling at low speed for 1 to 2 minutes.

Cutting with the Saw



THINK SAFETY!

IMPORTANT!

Use full throttle while cutting! Forcing the saw into the work reduces cutting performance and also increases operator fatigue!

Clear a safe work area before cutting.

Stop the saw before moving it from the work area.

Always wear hearing protection (ear plugs or ear muffs) to protect your hearing

Always wear eye protection such as a face shield or goggles.

Always wear gloves when operating the saw.

Use full-throttle while cutting, and apply only enough bar pressure to maintain engine speeds of 7000-8000 rpm.

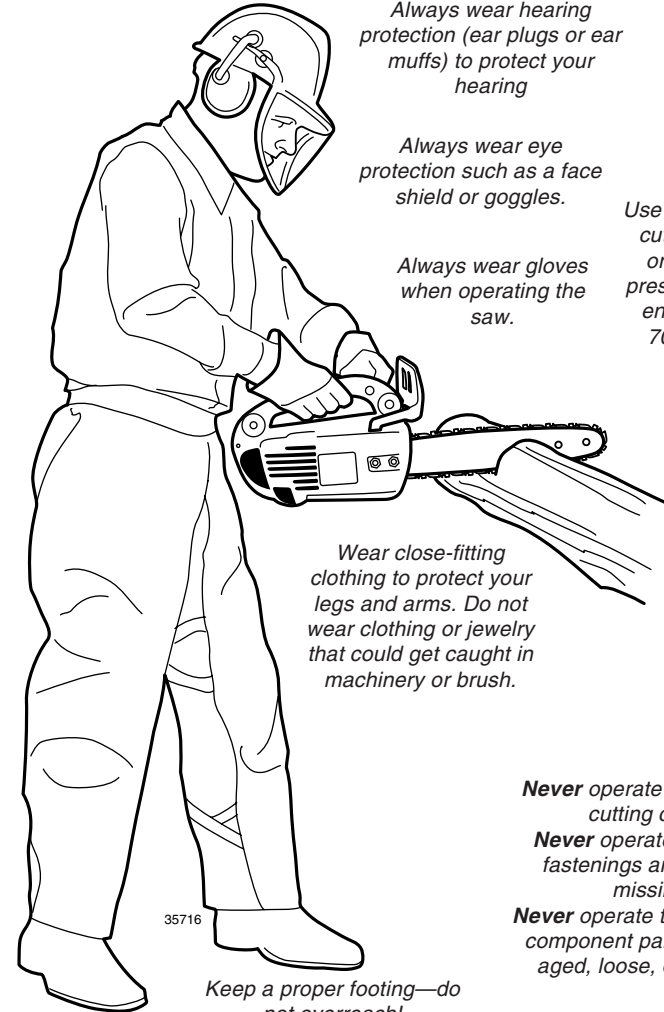

Wear close-fitting clothing to protect your legs and arms. Do not wear clothing or jewelry that could get caught in machinery or brush.

Never operate with a loose cutting chain!

Never operate the saw if fastenings are loose or missing!

Never operate the saw if any component parts are damaged, loose, or missing!

Keep a proper footing—do not overreach!

Wear appropriate non-skid footwear.

Chain Brake (cont.)

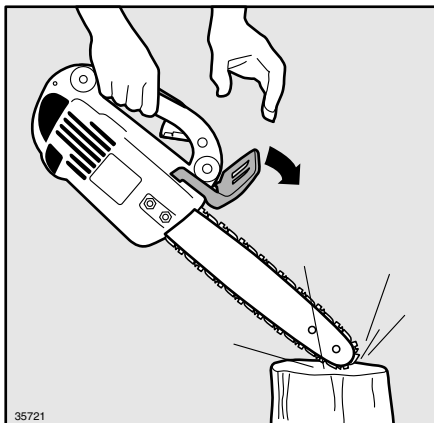
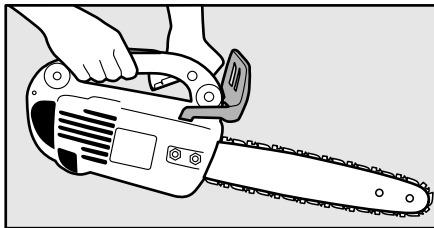

Chain Brake Inspection (engine "off")

1. Turn the engine "off," and make sure the ignition switch is in the "O" or "off" position.
2. Hold the saw with the bar tip 12 to 20 inches (30-50 cm) above a soft wood block.
3. Quickly release the front handle, allowing the guide bar tip to strike the wooden block.
4. The chain brake must engage as soon as the bar tip strikes the wood.



WARNING!

The above procedure must cause the chain brake to engage! If the chain brake does not fully engage during this test, do not operate the saw! Return the saw to your dealer for repairs!

Chain Brake Maintenance

- Keep the brake mechanism clean and free of sawdust or debris.
- If the chain brake becomes damaged or worn, or fails to completely engage or release the clutch drum, return the saw to your dealer for repairs.

CAUTION!

- Never start or operate this saw while the chain brake is engaged!
- Never carry the saw by the brake lever! Carry the saw by the front handle.
- Always disengage the chain brake before removing or replacing the clutch cover!
- Never make carburetor adjustments while the chain brake is engaged!

Carburetor Adjustments

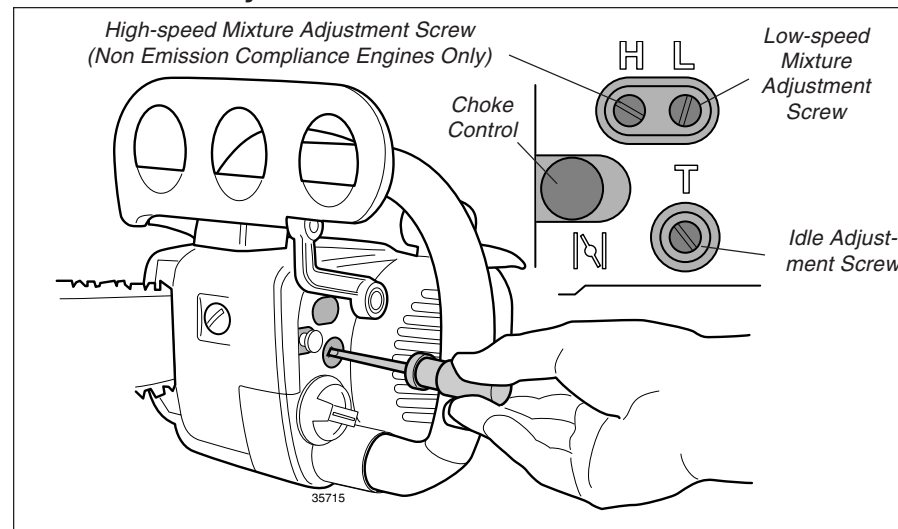

A clean and unrestricted airflow is essential to your saw engine's performance and durability! Before attempting any carburetor adjustments, inspect and clean the engine air filter as required! Procedures for maintaining this saw's air cleaner are described on page 27 of this manual.

Before starting the engine

1. Inspect saw chain tension, and adjust if necessary. (see page 13)
2. Make sure the chain brake is disengaged, and that the saw chain is free to rotate.

Start the engine, warm the engine to operating temperature. Place the saw on the ground, and adjust the carburetor as follows:

Idle speed adjustment (engine idling)

Use a screwdriver to slowly turn the idle speed adjusting screw in or out until the engine idles at 2,600-3,000 rpm (min⁻¹).



WARNING!

The saw chain must never rotate at engine idle speed!

Low and High Mixture Adjustments for Emission Compliance Engines.

Low Speed Mixture (engine idling at operating temperature)

1. Using a small screwdriver, slowly turn the low speed mixture screw clockwise (lean mixture), and note any changes in engine rpm. See illustration above.
2. Next, turn the low speed mixing screw counter-clockwise (rich mixture) and note any changes in engine rpm.
3. Adjust the low speed mixture screw to provide the smoothest possible idle with no sacrifice in acceleration.
4. If necessary, readjust the idle speed screw for an engine idle speed of 2,600-3,000 rpm (min⁻¹).

High Speed Mixture

High-speed adjustments are factory set and can not be adjusted.

Carburetor Adjustments (cont.)

Low and High Mixture Adjustments for Non Emission Compliance Engines.

Low Speed Mixture (engine idling at operating temperature.

1. Using a small screwdriver, slowly turn the low speed mixture screw **clockwise** (lean mixture) and note any changes in engine rpm.
2. Next, turn the low speed mixture screw **counter-clockwise** (rich mixture) and note any changes in engine rpm.
3. Adjust the low speed mixture screw to provide the smoothest possible idle with no sacrifice in engine acceleration.
4. If necessary, readjust the idle speed screw for an engine idle speed of 2,600-3,000 rpm (min⁻¹).

High Speed Mixture

CAUTION:

Do not run saw at full throttle with no load. If run in this condition, seizure can occur.

CAUTION:

Do not adjust H-speed needle to less than 1 turn. If run at less than 1 turn, seizure can occur.

1. No adjustment is necessary when the saw is new.
2. After approximately 10 hours running, readjust the H-needle to 1 1/4 turns ($\pm 1/4$ turn).

Low and High speed adjustment. Standard opening.

L 1 1/8 \pm 1/4 turn
H 1 1/4 \pm 1/4 turn
“Standard opening” means number of turns from the fully closed position by turning needle gently counter-clockwise.

Chain Brake

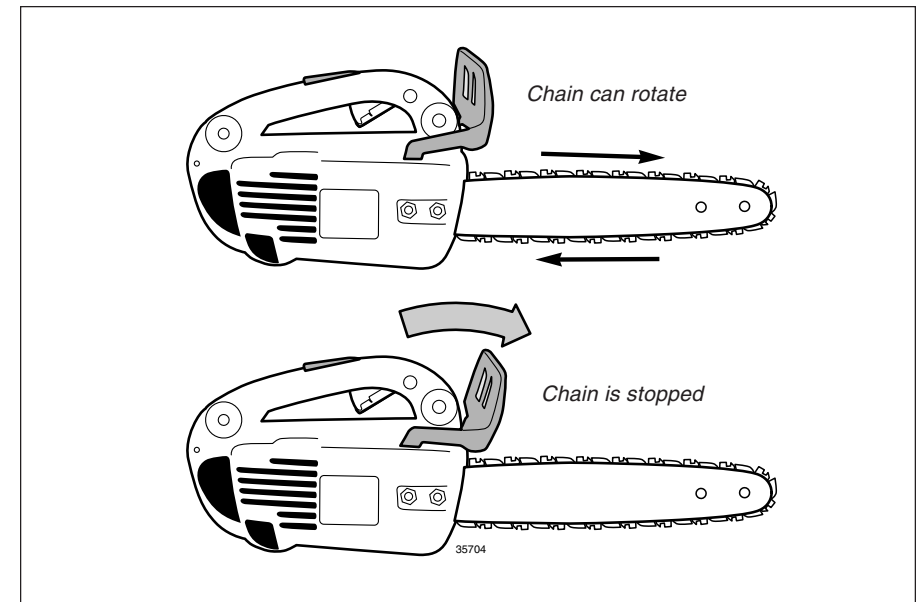

Chain Brake Operation

The Shindaiwa 357 saw is equipped with an inertial chain brake that stops the saw chain whenever the brake lever is moved to the forward (engaged) position.

- Engaging the brake lever causes a brake band to tighten around the clutch drum, stopping the chain.
- The chain brake is designed to engage whenever the brake lever strikes the operator's hand.
- The chain brake can also be activated by pushing the brake lever forward manually.
- To release (disengage) the chain brake, pull the brake lever toward you.



WARNING!

The chain brake is installed only to reduce the risk of injury from kickback! The chain brake is not a substitute for careful operation!

IMPORTANT!

Release the throttle whenever the chain brake is activated!